

Table of Contents

Preface to the First Edition ix

Preface to the Second Edition xiii

PART 1—FUNDAMENTALS OF CONSTITUENTS FOR COMPOSITES MANUFACTURING

1. Introduction	3
Examples of Products Made Using Different Manufacturing Techniques	3
General Characteristics of Manufacturing of Composites	15
Functions of the Constituents of Composites	22
References	48
Appendix	48
Homework	50
2. Matrix Materials	51
Introduction	51
Different Types of Matrix Materials and Their Performance	51
Thermoset Matrix Materials	56
Phenolic and Carbon Matrices [3]	100
Thermoplastic Resins	101
Fillers, Colorants, and Other Resin Modifiers [3]	107
Metal and Ceramic Matrices [3]	108
Polymer Nanocomposites	109
References	127
Homework	128

3. Reinforcements—Fibers 129
General 129
Individual Filaments 130
Tows 147
Fabrics and Other Reinforcement Forms 147
Deformation of a Bed of Fibers (After Gutowski [2]) 154
References 168
Homework 169

PART 2—TECHNIQUES FOR COMPOSITES MANUFACTURING

**4. Hand Laminating (or Wet Lay-up) and the Autoclave
Processing of Composites 175**
Hand Laminating (or Wet Lay-Up) 175
Autoclave Processing 177
References 236
Homework 238

5. Filament Winding and Fiber Placement 239
Filament Winding 239
Fiber Placement Process 265
References 266
Homework 266

6. Pultrusion 267
General 267
Materials 269
Combination of Other Processes With Pultrusion 272
Factors Affecting the Pultrudability of a Composite Component 273
Summary 279
References 279

7. Liquid Composite Molding 281
Introduction 281
Materials 290
Mold Filling 298
In-mold Cure 322
References 326
Homework 327

8. Long Fiber Thermoplastic Matrix Composites 329

Introduction 329
 Materials 331
 Preliminary Material Combinations 335
 Fabrication of Final Product 341
 References 384

9. Automated Composites Manufacturing 387

General 387
 Automated Fiber Placement 389
 4D Printing (or Moldless Composites Manufacturing) 413
 Conclusion 426
 References 426

Index 429

About the Author 437

Preface to the First Edition

This book is a culmination of efforts and experience that I have gathered over the past 15 years in teaching the course Manufacturing of Composites at Concordia University; the training of engineers at local aircraft companies; and research activities on analysis, design, and the manufacturing of composites over the past three decades.

I came to work on composites from a mechanical engineering background. This may be similar to many other people in the late 1970s and the 1980s. I first worked on the mechanics of composites. For mechanics problems, we assume that the resins and fibers possess certain properties and that most resins will behave similarly as long as they are of the same category (for example, epoxies). As I got to know the field, I came into contact with people in many industries and found that there exists a whole world of knowledge and experience for composites manufacturing. In order to have sufficient expertise in composites, one must know not only the mechanics of the materials/structures but also the intricacies of their manufacturing processes.

When I listened to presentations from people across various industries talking about composites manufacturing, they showed beautiful parts that were very inspiring. When I attended industrial shows, companies usually exhibited excellent parts that inspired me even more. However, the question that always came to my mind was: What is the principle behind the manufacturing of these parts? How can one grasp the concepts and principles that can provide such beautiful and inspiring components?

There are a few books on composites manufacturing that exist in the literature. One well-known book is that of George Lubin, titled *Handbook of Composites*, which is a comprehensive presentation of many aspects of composites and composites manufacturing. Another book is that of Brent Strong, *Fundamentals of Composites Manufacturing*. This book presents the fundamentals of composite manufacturing, describing the ingredients: matrix, fibers, interface, and the main processes for composite manufacturing. This book deals more with the practical aspects of composites manufacturing. In 1997, T.G. Gutowski's book *Manufacturing of Composites* came out. This book is a collection of works of well-known scientists in the field and goes more into the scientific aspects of composites manufacturing. Also in 1997, a book entitled *Composite Materials, Processing, Fabrication and Applications* was published by Mel M. Schwartz on composites manufacturing processes. In 2000, Sanjay Mazumdar's book entitled *Composites Manufacturing: Materials, Product, and Process Engineering* came out. It deals with the practical aspects of composites manufacturing. These excellent books on composites manufacturing provide essential knowledge for the field.

However, during my 15 years of teaching the course *Composites Manufacturing*, I have found that the existing literature presents composites manufacturing either from the practical point of view (Strong), as a collection of opinions of scientific experts (Gutowski), or as a collection of different processes (Mazumdar). The existing literature describes more of WHAT processes have been developed. Little attention is paid to WHY these processes have been developed. As its name implies, composites is a field that requires knowledge from many fields. The manufacturing of composites involves a significant amount of knowledge in both materials and chemistry. For mechanics people, trying to have a grasp of the chemical aspects of composites manufacturing can be daunting.

From the learner's point of view, if they understand the WHY, then it may be easier for them to grasp the essentials of composites manufacturing.

The objective of this book is to present composites manufacturing from the WHY standpoint, in addition to the WHAT. The rationale as to why things are done in a certain way is explained. The book is intended for students from different backgrounds such as mechanical engineering, aerospace engineering, civil engineering, materials engineering,

and chemical engineering. It covers the main principles governing manufacturing using composites.

This book is divided into two parts. The first part deals with the fundamental elements for composites manufacturing. This includes a discussion on the essential principles behind composites manufacturing in the Introduction. This is followed by a discussion on Matrix Materials in Chapter 2 and a discussion on Reinforcements in Chapter 3. The second part presents the five most common techniques for composites manufacturing. These are Manufacturing Using Autoclave in Chapter 4, Filament Winding in Chapter 5, Pultrusion in Chapter 6, Liquid Composite Molding in Chapter 7, and Thermoplastic Composites in Chapter 8.

The notes that have been used for my course have helped nearly a thousand of my students over the past 15 years. This book is a written version of the instructional materials I have given to these students. I hope that this book will be of help to future students and also to would-be instructors.

I have received assistance from many people during the preparation of this book. I thank the students from the course of Manufacturing of Composites at Concordia University for asking questions and giving comments and feedback on the course delivery over the years. I thank Dr. Ming Xie for creating most of the drawings, Dr. Ngo Tri Dung for making the chemical formulae, Mr. Heng Wang for doing the calculations for the examples, and Dr. Minh Tan Ton That for proofreading Chapter 2.

I thank my mother Hoa Thi Tho for giving me the appreciation of hard work and the inspiration for moving ahead; my wife Do Thi Dong for her love, encouragement, and support; and my children Vincent, Glenn, Sabrina, and Victoria for the joy they give me.

Suong Van Hoa
Montreal
November 2008

Preface to the Second Edition

The first edition of this book has been used in the course Manufacturing of Composites over the past 8 years at Concordia University. During this time, many new developments have occurred. Polymer nanocomposites have received significant attention from the world's composites community. This is given coverage in Chapter 2 as part of the augmentation of matrix material properties. Out-of-autoclave prepregs are used more and more. This topic is given more coverage in Chapter 4 after the presentation using autoclave materials. Thermoforming processes using thermoplastic composites are also used more and more. This topic was added to Chapter 8. Automated fiber placement techniques have been used more and more by many manufacturers. This topic was added into a new Chapter 9. A brand-new topic that I recently thought of, 4D printing of composites, was also added to the end of Chapter 9. This is derived from the deposition of composite layers by automation (3D printing) plus some form of shape reconfiguration afterward. Many students have pointed out typing errors in the first edition. Many thanks are extended to those students who have taken the Manufacturing of Composites courses over the past 8 years. These errors have been corrected in this second edition.

Suong Van Hoa
Montreal, January 2017

Fundamentals of Constituents for Composites Manufacturing

Introduction

Advanced composite materials have been used to fabricate many structural parts in engineering applications. This is due to their many attractive characteristics such as light weight, high strength, high stiffness, good fatigue resistance, and good corrosion resistance. Also, the ability to manufacture parts with complicated geometry using a few number of components enables manufacturers to save costs as compared to the same parts made of conventional metallic materials. Before presenting the fundamental aspects of manufacturing and different techniques used for composites manufacturing, it is appropriate to present composite structural parts currently in use and the main techniques that have been used to fabricate them.

1. EXAMPLES OF PRODUCTS MADE USING DIFFERENT MANUFACTURING TECHNIQUES

Figure 1.1a shows a schematic of an Airbus 380 airplane (the largest airplane in the world as of 2008). This airplane has more than 50% of its structure made of composite materials. These components include the flaps, ailerons, rudder, radome, etc. Most of these components are flat (or plates or shallow shells) in shape, and they are usually made using Hand-Lay-Up and Autoclave Molding techniques. Figure 1.1b shows a schematic of the hand-lay-up fabrication technique and a representative lay-up sequence. Autoclave molding is a well-established method for composites used in the aerospace industry with certified

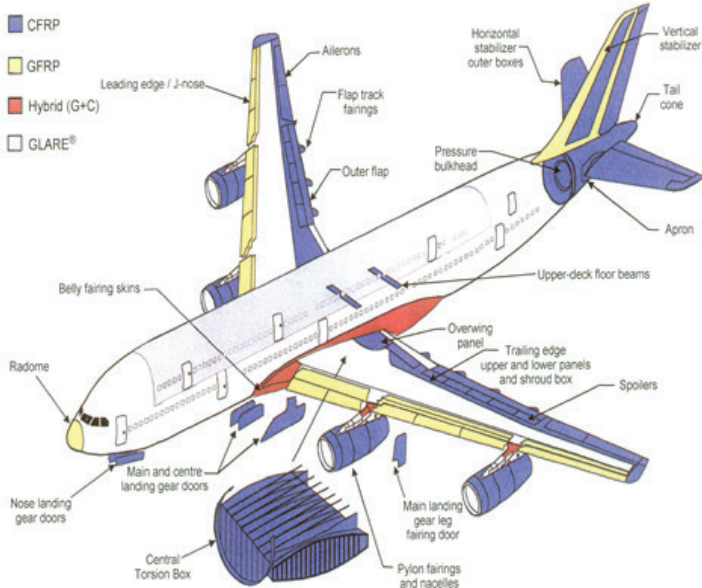

FIGURE 1.1a Airbus 380 with its composite components. (<http://www.specialchem4adhesives.com/home/editorial.aspx?id=752>)

resins and fibers. A photograph of an autoclave is shown in Figure 1.1c. Autoclave molding will be discussed in detail in Chapter 4. Recently Out-Of-Autoclave prepregs have gained in popularity. The process for out-of-autoclave prepregs is similar to prepregs designed for autoclave except that no pressure is used besides vacuum. This is the reason for another name for this process, called Vacuum Bag Only.

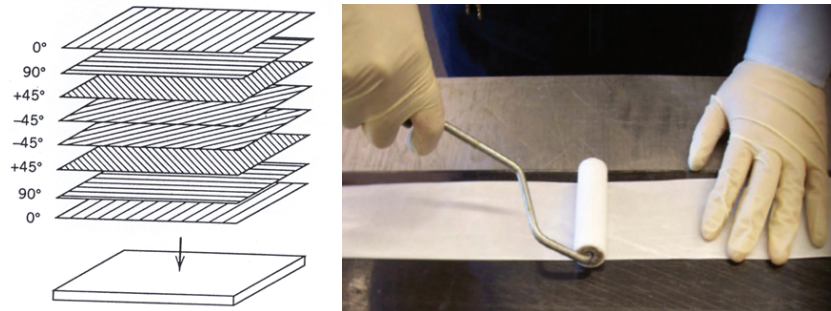

FIGURE 1.1b Schematic of the hand-lay-up fabrication method and a representative lay-up sequence. Individual layers can be cut by hand or by a computerized machine cutter. The layers can be stacked one on top of the other by hand or by a robot.



FIGURE 1.1c Photograph of an autoclave.

Figure 1.2a shows a pressure vessel made of composite materials using the combination of hand-lay-up and filament winding processes. Composite pressure vessels are lightweight and can contain pressures higher than those contained by metallic vessels. These components are made using a Filament Winding process (Figure 1.2b). Figure 1.2c shows a photograph of a filament winding machine. The filament winding process will be discussed in detail in Chapter 5.



FIGURE 1.2a Composite pressure vessel made by combination of hand-lay-up and filament winding.

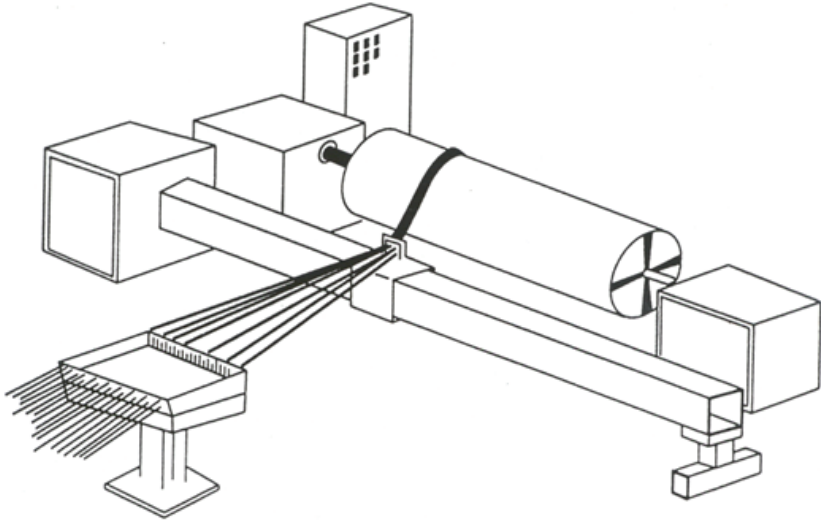

FIGURE 1.2b Schematic of the filament winding process (courtesy of Wiley Interscience).

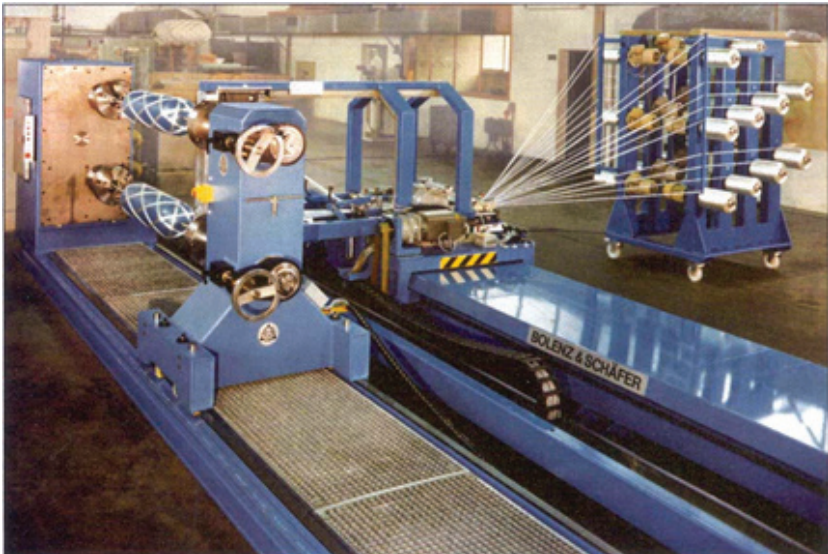

FIGURE 1.2c A two-spindle winder with a carriage-mounted resin bath and a free-standing creel in the background (courtesy of Composites Technology magazine, August 2005).

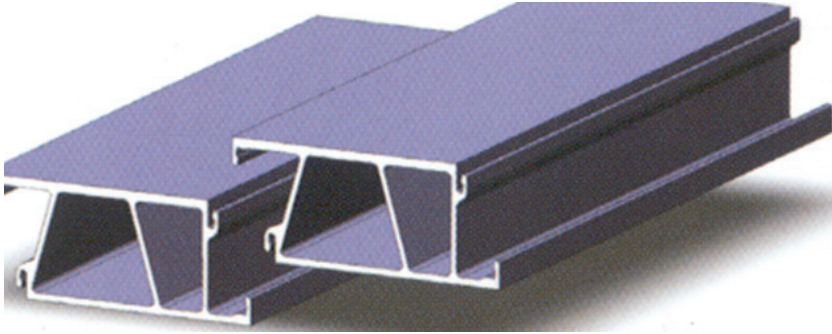

FIGURE 1.3a A composite pultruded connector.

Figure 1.3a shows a component made using Pultrusion. Pultrusion is used to make many structures for civil engineering applications. Figure 1.3b shows the schematic of the pultrusion process, and Figure 1.3c shows the photograph of a lab-scale pultrusion machine. Pultrusion will be discussed in Chapter 6.

Figure 1.4a shows a composite component made using the Liquid Composite Molding method (curved piece). Liquid composite molding has been used to make automobile composite components. Figure 1.4b shows the schematic of the liquid composite molding process, and Figure 1.4c shows a pump, a mold, and accessories for the liquid composite molding hardware. Liquid composite molding will be discussed in Chapter 7.

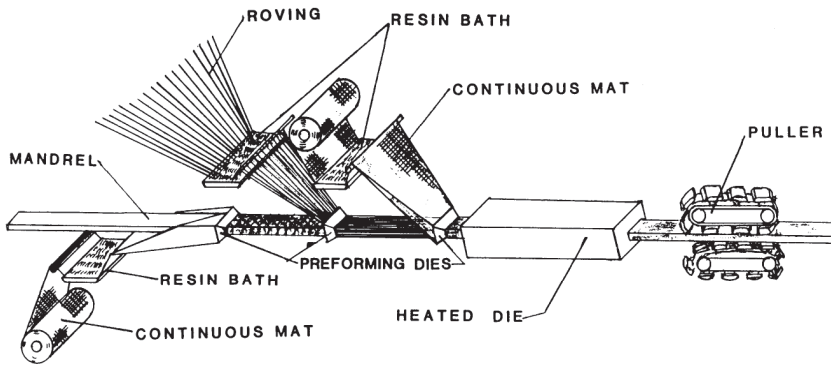

FIGURE 1.3b Schematic of the pultrusion process (courtesy of Chapman and Hall).

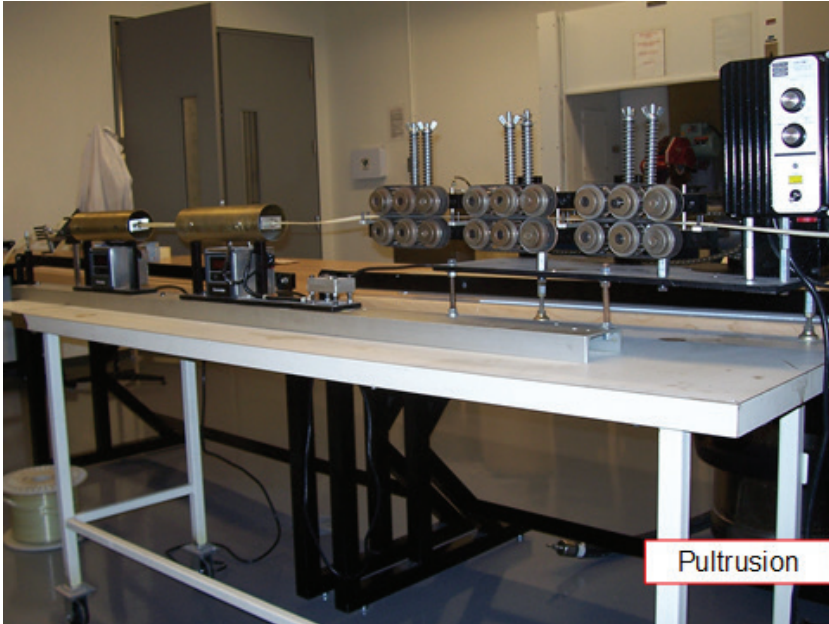

FIGURE 1.3c A lab pultrusion machine.

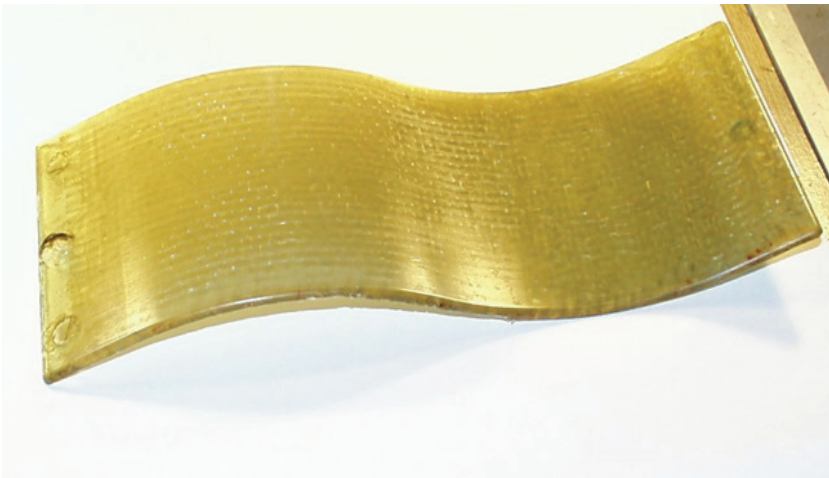

FIGURE 1.4a A curved piece made by liquid composite molding method.

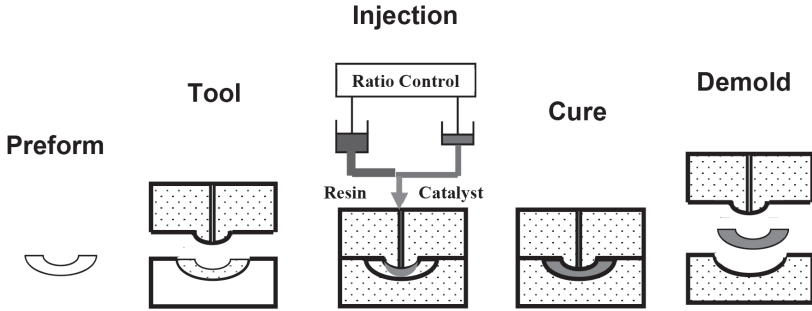

FIGURE 1.4b Schematic of the liquid composite molding process.

Figure 1.5a shows a composite wing box panel made using thermoplastic composites and the compression molding method. Figure 1.5b shows the schematic for the thermoplastic composite molding process. Figure 1.5c shows a compression molding machine. The molding of thermoplastic composites will be discussed in Chapter 8. A variation of the compression molding process is thermostamping. In this pro-



FIGURE 1.4c Instrumentation for liquid composite molding: Pump, mold, and accessories. Resin is filled into the vertical cylinder and then pumped into the mold cavity on the left-hand side.

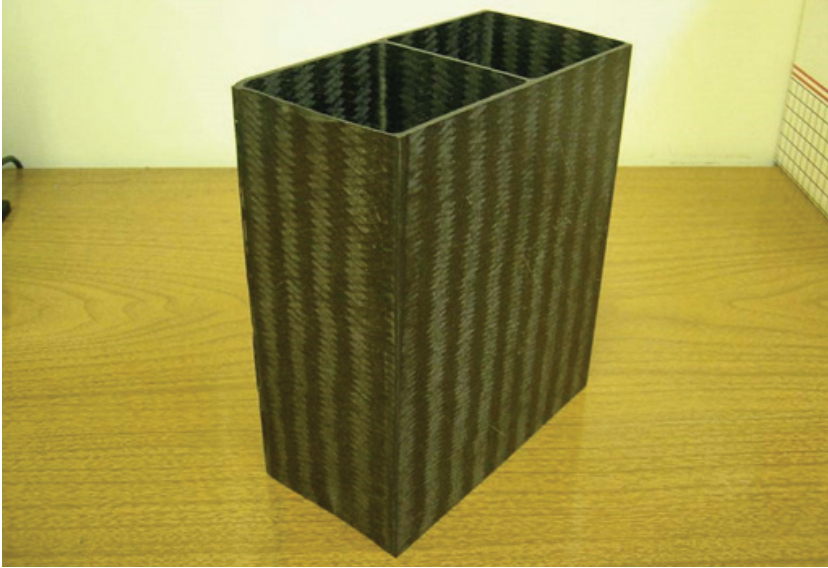

FIGURE 1.5a A thermoplastic composite wing box panel made by compression molding.

cess, a blank of thermoplastic composites is first heated in an oven adjacent to the compression molding press. Once the blank has reached melting temperature, it is transferred quickly to the compression mold and molded quickly. This process allows for the whole sample to reach

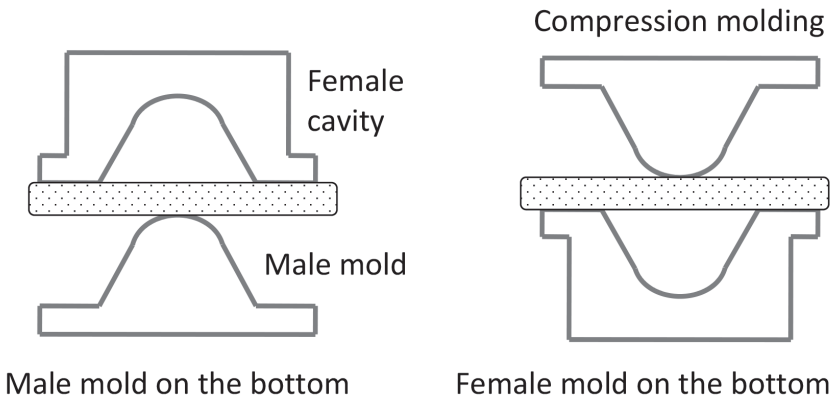

FIGURE 1.5b Schematic of the thermoplastic composite molding process.

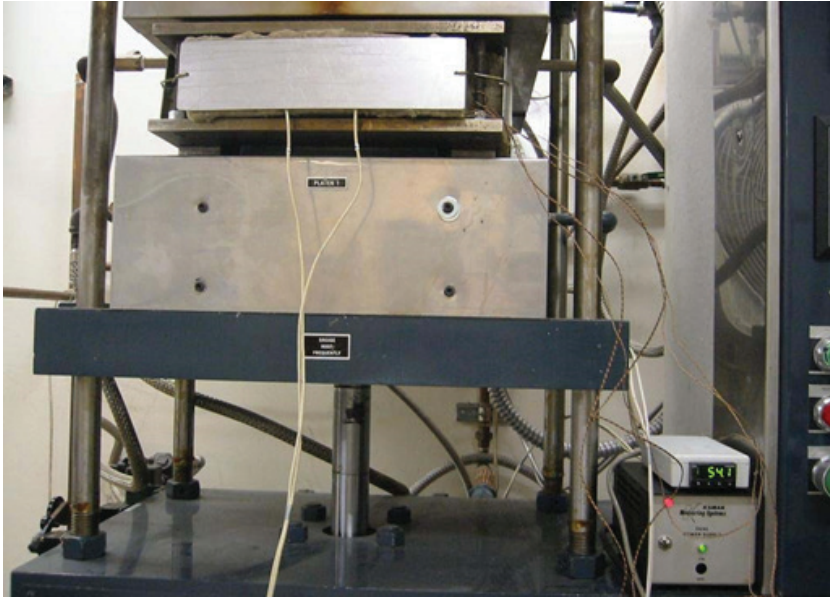

FIGURE 1.5c A compression molding machine.

uniform molten state before molding, which can allow the molding of parts with complex geometry. Figure 1.5d shows a schematic of the steps in the thermostamping process. Figure 1.5e shows the back side of a thermostamping machine (where the heater is). Figure 1.5f shows a thermoplastic composite part made by thermostamping.

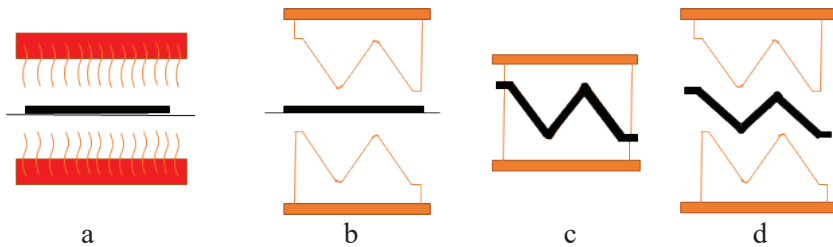

FIGURE 1.5d Schematic of the steps in thermostamping of thermoplastic composites: (a) The composite blank (in black) is placed between two infrared heaters. (b) The composite blank is quickly (within a few seconds) transferred to a space between two heated half-molds. (c) The heated half-molds are closed to form the shape. (d) After a few minutes, the half-molds are opened, and the part is removed from the mold.



FIGURE 1.5e Back side of a thermostamping machine.

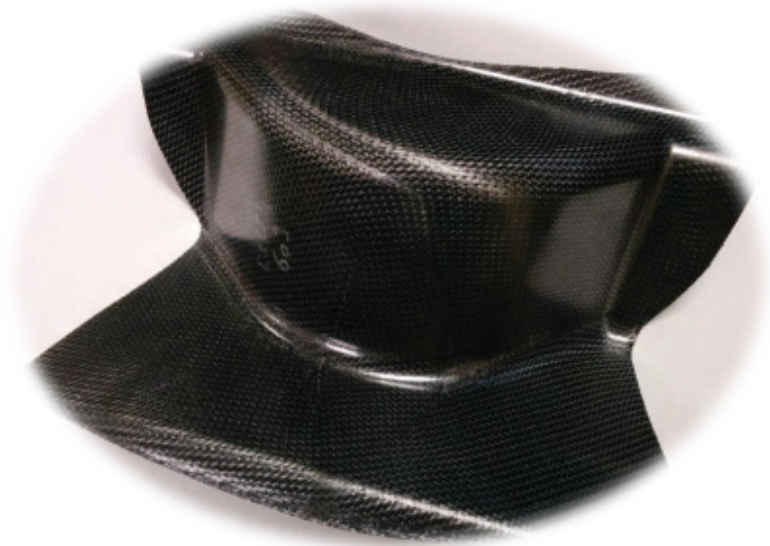

FIGURE 1.5f A thermoplastic composite part made by thermostamping.



FIGURE 1.6a A thermoplastic composite tube made by the fiber placement process.

Figure 1.6a shows a thermoplastic composite tube made by the fiber placement process. Figure 1.6b shows the schematic of the thermoplastic composite placement process, and Figure 1.6c shows a photograph of a fiber placement machine. Fiber placement of thermoplastic composites will be discussed in Chapter 8.

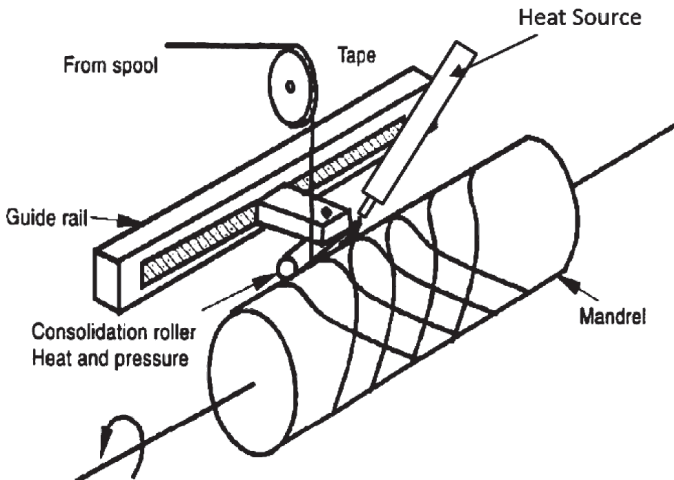

FIGURE 1.6b Schematic of the thermoplastic composite placement process.

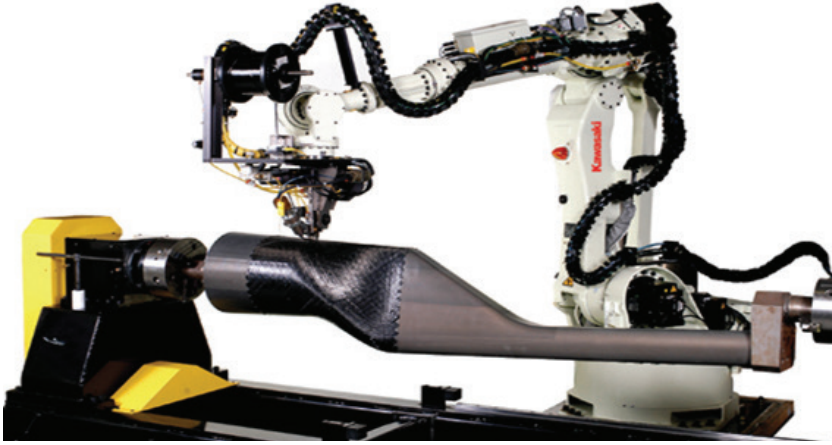

FIGURE 1.6c An automated fiber placement machine.

A few specific features can be extracted from the previously discussed components and the different manufacturing techniques used to fabricate them.

Normally, structural components can be classified according to each one's shape, and the manufacturing technique used depends significantly on the shape of the component as follows:

- *Relatively thin flat plate or shallow shell with free edges.* Normally, aerospace components have these types of shapes. These are usually made using the hand-lay-up method. The autoclave is the common tool used for making aerospace composite components having these shapes. These shapes can also be made using liquid composite molding and automated fiber placement.
- *Components of revolution, such as cylindrical or spherical pressure vessels and pipes.* These structures usually have no free edges (except for the end openings). These are usually made using the filament winding method. They can also be made using the automated fiber placement method.
- *Components having constant cross section such as tubes, rods, or even components with complex but constant cross section along the length such as door frames.* These are usually made using the pultrusion method.

- *Components having complex 3D configurations.* These can be thick or thin and are usually made using the Liquid composite molding method. Automated fiber placement method can also be used.
- *Large structures such as boat hulls, wind turbine blades, etc.* These are made using a modified form of liquid composite molding such as Vacuum Assisted Liquid Composite Molding. A special process called SCRIMP (Seaman Composite Resin Infusion Molding Process) is usually used to make boat hulls.
- *The fiber placement method can be used to make small and large components, either without free edges or with free edges.* These machines are versatile but require a large amount of capital investment (in the order of several million dollars).

2. GENERAL CHARACTERISTICS OF MANUFACTURING OF COMPOSITES

Generally, manufacturing using composites involves the processing of two main ingredient materials to make a final product. The ingredients involve the matrix and fiber materials. This processing requires the following:

- Good bonding between matrix and fibers
- Proper orientation of the fibers
- Good amount of volume fraction of fibers
- Uniform distribution of fibers within the matrix material
- Proper curing or solidification of the resin
- Limited amount of voids and defects
- Good dimensional control for the final part

The implications of these are as follows:

Good bonding between matrix and fibers: To provide reinforcement so that properties such as strength and stiffness can be enhanced, the fibers need to be bonded to the matrix. If, the fibers are not properly bonded to the matrix at a certain location, *dry spots* will occur. At this location, there is no proper shear transfer of load between fiber and matrix, and the domino effect (as will be discussed in Section 3.1 of this chapter) will occur. These locations will also serve as nuclei for cracks

to form. However, there are situations, such as the requirement to absorb impact energy, where partial dry spots may enhance the energy-absorbing capability of the composite.

Proper orientation of the fibers: Proper orientation of the fibers is important because properties such as stiffness and strength are very sensitive to fiber orientation. If the fiber orientation deviates by about 10° from the 0° direction, the stiffness can drop by more than 30%. The modulus along the x direction of a sample where fibers direction is at an angle θ with respect to the x direction is given by

$$E_x = \frac{E_1}{m^4 + \left(\frac{E_1}{G_{12}} - 2\nu_{12} \right) n^2 m^2 + \frac{E_1}{E_2} n^4}$$

where E_1, E_2 are the moduli along and transverse to the fiber directions, respectively; G_{12} is the in-plane shear modulus; ν_{12} is the major Poisson ratio; and m and n are $\cos\theta$ and $\sin\theta$ respectively. Figure 1.7 shows the effect of misorientation on the stiffness E_x of the laminate. It can be seen that a deviation of 15° can cause a reduction in the modulus by six times. There can also be significant loss in compressive properties

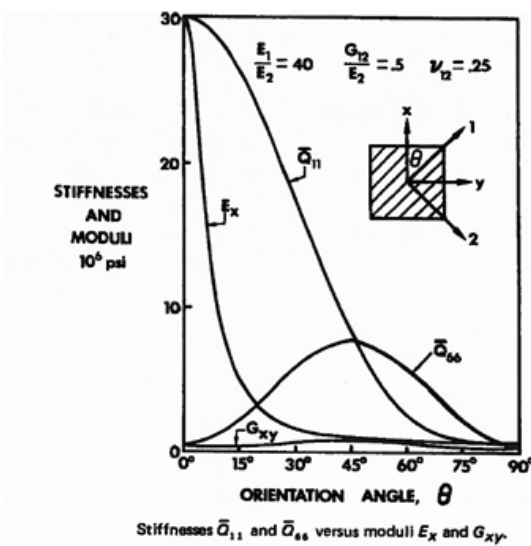

FIGURE 1.7 Variation of the modulus of a unidirectional laminate with respect to fiber orientation.

due to fiber misorientation. It is therefore very important to keep the fibers as straight as possible during manufacturing to avoid the loss in properties.

The misorientation of the fibers can be due to many reasons as shown in the following section:

- Filaments in their natural state tend to be wavy. This is due to the large aspect ratio (length over diameter). Apparent observation may not show this waviness, but close observation will show this microwaviness. To overcome this microwaviness, fibers need to be kept under slight tension during manufacturing.
- The flow of the liquid resin transverse to the fiber direction may deflect the fibers and cause misorientation. This can happen during autoclave curing if dams are not used to prevent resin flow transverse to the fiber direction within the plane of the laminate. This can also happen during liquid composite molding if resin is allowed to flow transverse to the fiber direction.
- Overlacing of fibers one over the other (such as in weaving) can cause fibers to deviate from the intended orientation.
- Reinforcing along the thickness direction with methods such as stitching, Z pinning, or 3D weaving can cause fibers to deflect from their intended orientation.
- Hard pressing of a stiff roller with a small radius may cause fiber waviness during automated fiber placement.
- Molding over sharp and complex geometry may cause the fibers to shear or to rotate away from their intended orientations.
- Human errors during hand-lay-up can cause fiber misorientation.

Good amount of volume fraction of fibers: In composite materials, the fibers provide stiffness and strength. Therefore, the larger the amount of fibers, the better these properties will be. The amount of fibers is usually expressed in terms of volume fraction, v_f , which is defined as:

$$v_f = \frac{V_f}{V_c} \quad (1.1)$$

Where V_f is the volume of fibers and V_c is the volume of the composite material.

Properties such as stiffness of a unidirectional composite along the axial direction is given by the rule of mixtures:

$$E_c = E_f v_f + v_m E_m \quad (1.2)$$

Where subscript f refers to the fiber, and m refers to the matrix.

The fiber volume fraction and matrix volume fraction are related by:

$$1 = v_f + v_m + v_v \quad (1.3)$$

Where the last term refers to volume fraction of voids.

For good quality composites, the amount of voids should be minimal (less than 1%), and equation (1.3) can be approximated to be:

$$1 = v_f + v_m \quad (1.4)$$

Using equation (1.4) in (1.2), the modulus is expressed as:

$$E_c = (E_f - E_m)v_f + E_m \quad (1.5)$$

The modulus is linearly proportional to the fiber volume fraction. Therefore, the larger the fiber volume fraction, the better the mechanical properties. It should be noted, however, that the fiber volume fraction cannot be 1; this would mean that there is no matrix material, which in turn would mean dry bundles of fibers, and the domino effect as mentioned in Section 3.1 would prevail.

Uniform distribution of fibers within the matrix material: Figure 1.17 shows a cross section of a unidirectional composite layer. The white dots show the cross section of the fibers, and the dark area represents the matrix. One can see that, at the fine scale, the distribution of the fibers is uniform in some regions but not in others. A region where there is more matrix than fiber is called *resin-rich area*. It is not a good idea to have large and many resin-rich regions because there are weak areas. Resin-rich areas can also result due to lack of consolidation pressure. The low pressure used in an out-of-autoclave technique may give rise to resin-rich areas. Upon loading, these areas can serve as locations

for crack nucleation. Compression properties can also decrease due to resin-rich areas because these may cause deviation in fiber orientation.

Proper curing or solidification of the resin: In the manufacturing of polymer matrix composites, the resin first occurs in the form of low viscosity liquid so that it can flow and wet the surface of fibers. After wetting is complete, the resin needs to solidify and harden. For thermoset resins, this is called *curing*; and for thermoplastic resins, this is called *solidification*. In both cases, the resin needs to be hard and stiff for the reinforcement effect to take place. If there are regions where the resin is not hard enough, these regions are weak and can serve as crack nucleation areas.

Limited amount of voids and defects: Voids and defects may be formed during the manufacturing of composites. Voids can arise due to lack of compaction of many layers together or due to low pressure in the resin during curing. The amount of voids needs to be kept to a minimum to be acceptable. A limit of about 1% is commonly used. Defects such as delamination between layers, cracks, fiber misorientation, nonuniform fiber distribution, etc. may not be acceptable.

Good dimensional control for the final part: Polymeric resins shrink when they change from a liquid state to a solid state. The degree of shrinkage can be between about 5% to 8% depending on the type of materials. This shrinkage of the material may cause residual stresses in the part, and also out of dimensions or warping. For a large structure such as the wing of an aircraft, a few percentages of shrinkage of the material can translate into significant deformation of the structure. Another problem that may occur is the surface finish of parts such as automobile panels that may be adversely affected by this shrinkage. Resins with Low Profile Additives are usually used to control shrinkage.

2.1. Metal Versus Composite Manufacturing

Manufacturing using composites has differences from manufacturing using metals:

- In metals such as steel or aluminum, materials with finished forms such as rods, slabs, and sheets are available. The

making of a finished product such as a car body, the box frame for a computer, etc. only requires the working to be on these finished forms. Processes such as cutting, bending, forming, welding, drilling, etc. are used on these finished forms to make the finished product.

- In composites, the steps that transform the finished form to the final structure are usually bypassed. A manufacturer using composite materials has to work directly from the ingredients of fiber and matrix to make the finished product itself. Figure 1.8a shows the different stages of existence of composite constituents up to the final product:

—*Stage a*: At this stage, the materials appear in raw, basic form. For fibers, these consist of fiber either in the form of filaments or fiber bundles. Fibers may also be woven into fabrics or braided into braided preform. For the matrix, the material usually appears in liquid form for thermoset resins or in granular form in the case of thermoplastics.

—*Stage b*: At this stage, the fibers and matrix may be combined into a single layer. In the case of thermoset matrix composites, the matrix may appear in a semi-liquid, semi-solid form so that the sheet can hold its shape. In the case of thermoplastic composites, the matrix is solidified. This form for thermoset matrix composites is called prepreg. For thermoplastic composites, it is called towpreg.

—*Stage c*: At this stage, the layers in stage *b* are stacked on top of each other to make flat plate laminates. This intermediate step is important for the analysis where material properties are tested or calculated. However, this step is usually bypassed in the manufacturing process of practical composite parts.

—*Stage d*: This is the final stage where the final product configuration is formed.

The involvement of these stages in the different manufacturing processes is as follows:

- *Hand-lay-up* (without or with autoclave): Stages *a*, *b*, and *d* are involved. Stage *c* is bypassed.
- *Filament winding*: Stages *a* and *d* are involved. Stages *b* and *c* are bypassed.
- *Pultrusion*: Stages *a* and *d* are involved. Stages *b* and *c* are bypassed.
- *Liquid composite molding*: Stages *a* and *d* are involved. Stages *b* and *c* are bypassed (Figure 1.8b shows stages for liquid composite molding).
- *Thermoplastic composites*: Stages *a* and *d* are involved. Sometimes stage *b* and even stage *c* may be involved.
- The mentality of working with metals therefore cannot be applied when manufacturing using composites.

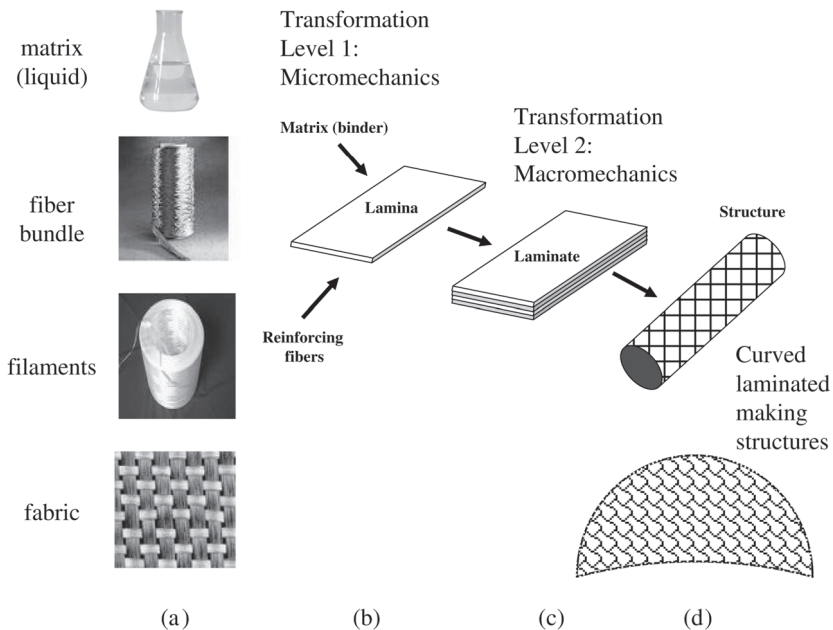

FIGURE 1.8a Stages of existence of constituents in the manufacturing of composites.

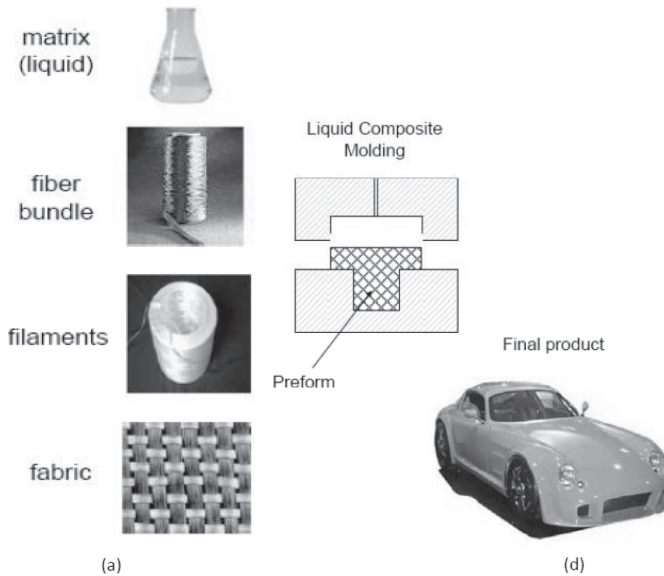

FIGURE 1.8b Stages of existence of constituents in the liquid composite molding process.

3. FUNCTIONS OF THE CONSTITUENTS OF COMPOSITES

There are two main constituents making up advanced composites: the fibers and matrix. The interface between the fibers and matrix is critical for the function of the composite material. The interface may be considered as a third constituent of the material. Each of these constituents will be presented in the following:

3.1. Fibers

Fibers provide strength and stiffness to the composite materials. Fiber materials are usually glass, carbon, or Kevlar. One may ask the question, “Why do composites appear in fiber form?” There are many reasons for this as follows:

3.1.1 Advantages of the Fiber Form

a) Strength of material in fiber format is better when compared to bulk format.

Automated Composites Manufacturing

1. GENERAL

Automated composites manufacturing refers to manufacturing methods where some form of automation is used. This is in contrast to the very manual method such as hand-lay-up. In the history of development of composite materials, manual methods have been used mostly. As a result, products that have been developed have been usually custom made. This has advantages and disadvantages. The advantages are that the method is very flexible, and it does not require investment for costly machineries. The disadvantages are the slow speed of production, variability of the quality and performance of the products, and the subsequent lack of standard for quality control and acceptance. With the increasing use of composites in many engineering structures, the increasing need for uniformity in the quality of the products, and the increasing need for fast rate of production, the need for automated composites manufacturing becomes more and more evident.

In the different techniques for manufacturing that have been presented in this book, there are methods of manufacturing where automation is used. These include filament winding and pultrusion. However these methods have limitation in the shape of structures that can be made. Filament winding is limited to bodies with surface of revolution such as cylinders or spheres. Even though filament winding can be used to make flat laminates using a paddle tool, it is difficult to ensure the flatness of the lay-up. Filament winding also requires that the surface of

the tool is convex. Pultrusion is limited to structures with uniform cross section, and the fiber orientation is limited mostly to be along the pulling direction. As such, techniques such as filament winding and pultrusion are not feasible to make composite structures for aircrafts, where the majority of technology and development for composites is made.

In the last decade, two methods of automated composites manufacturing that can be used to make aircraft structures have been developed. One is automated tape lay-up, and the other is automated fiber placement or automated tape placement. The main motivation for these developments is to increase the speed of manufacturing. While the most capable worker has difficulty exceeding the lay-down rate of 2.2 lb/hr (1 kg/hr), it is expected that automated tape lay-up or automated fiber placement can have a lay-down rate of about 15 to 25 lb/hr (6.82 kg to 11.36kg/hr).

A technique such as hand-lay-up cannot deposit materials fast enough. Considering a fuselage of about 500 cm in diameter and 1,500 cm long. If a laminate of 3 mm were to be laid, with the specific gravity of composite being about 1.8 g/cm³, the composite weight is 1,272 kgs. At the rate of 1.0 kgs/hour, it would take 1,272 hours for one worker. If 10 workers are involved, the time is 127 hours. If only 8 hour shift per day is involved, then this would take about 16 days). This simply is not practical, and, in the case of thermoset matrix composites, the prepregs have limited out time.

Automated tape lay-up is designed mainly for the deposition of thermoset composite tapes. The tapes are usually wide, with a tape width of about 12 inches (305 mm). By using wide tape, a large amount of material can be deposited per unit time. Automated fiber placement (or automated tape placement) utilizes narrower tapes (or tows). The widths of tapes for automated fiber placement varies from 1/8 inch to 1/2 inch (3.17 mm to 12.7 mm). To compensate for the narrower width, automated fiber placement machines can use heads that can deposit multiple tapes (tows) at the same time. As such, there are heads that can deposit either one tow or up to 32 tows at one time. The depositing head of the machine has individual cutters that can cut the individual tows. As such, the tow terminals can be cut to correspond to curved contours such as openings. There are advantages of using narrower tapes. One is the ability to follow curved contours such as openings. The other is the ease to steer the fibers such that the fibers can change their orientation within a surface. Another advantage is, in the case of depositing

thermoplastic composites, the narrow tow allows for relatively small heating beams (such as hot gas stream, laser beam, or ultrasonic beam) to heat the whole width of the tow. Automated fiber placement certainly has more versatility than automated tape lay-up and will be the focus in the remaining part of this chapter.

2. AUTOMATED FIBER PLACEMENT

2.1. Description

Automated fiber placement of composites is a new method for the manufacturing of composite structures using automation. The technique utilizes an automated fiber placement machine. A photo of the automated fiber placement machine was shown in Figure 1.6c and is repeated here in Figure 9.1a for convenience. Figures 9.1b and 9.1c show the schematic of the main regions of interest of the machine.

The machine consists of five main components:

- a. *A spindle axis to mount the mandrel.* This spindle provides the rotation of the mandrel.
- a. *A mechanism to deliver the composite tows to the noninjection point.* Composite tows can be single tow or multiple of tows. Simple machines can feed one tow at a time or a course of up to 32 tows is possible. The tow width can vary from 1/8 inch (3.17 mm) up to 1/2 inch (12.7 mm). Composite tows can be prepregs of thermoset composites, such as glass/epoxy or carbon/epoxy. Composite tows can also be tapes of thermoplastic matrix composites. The tows normally come from creels either mounted directly on the depositing head or from a chamber located in the vicinity of the machine. In the case of thermoset composites, to avoid some curing of the thermoset resin before the automated fiber placement process, the tow chamber is usually refrigerated.
- b. *A mechanism to heat the tows.* There are two types of heating: preheating and heating at the noninjection point area. Preheating refers to heating of the tow(s) before the noninjection point (region A in Figure 9.2). For thermoset composites, either preheating at region A is done, or the tool can be preheated right before material deposition, in the case where only a few layers are deposited.

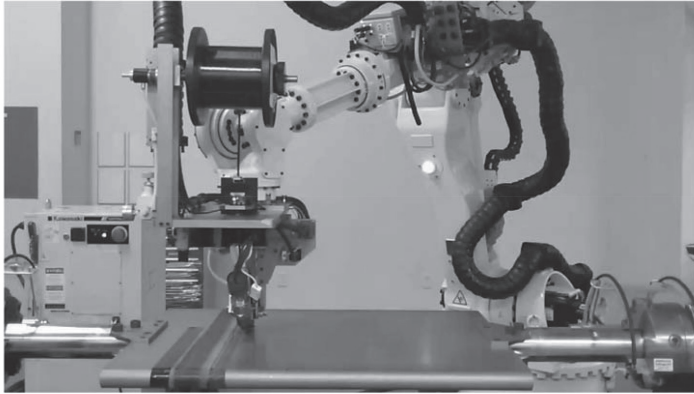

(a)

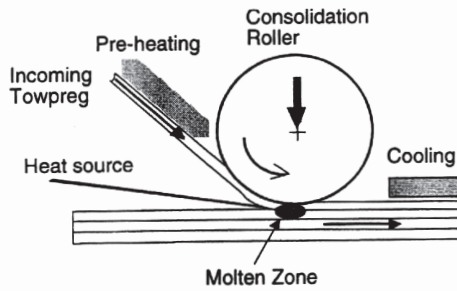

(b)

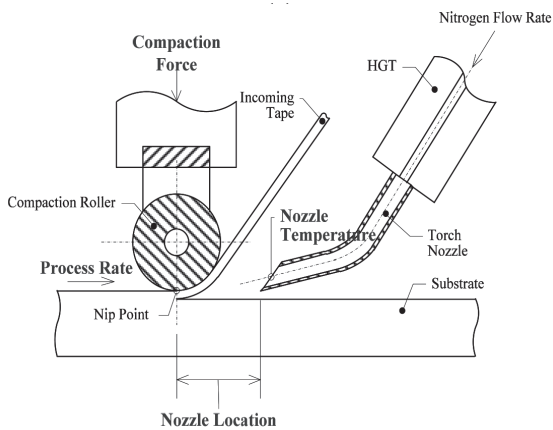

(c)

FIGURE 9.1 (a) Photo of an automated fiber placement machine, (b) schematic of an automated fiber placement machine, and (c) location close to the noninjection point.

For thermoset composites, heating is used to slightly decrease the viscosity of the resin. This in turn serves to increase the tack of the tow(s) to facilitate bonding to the substrate. For thermoplastic composites, preheating can help to enhance the melting and bonding that takes place at the noninjection point (region B). Preheating is usually done using infrared heaters. For machines using torch heating, because the heat zone is fairly large, even if the heating is focused at the noninjection point region, some preheating may take place in region A.

For thermoplastic composites, intense heating needs to be done at the noninjection point area (region B in Figure 9.2) to melt the thermoplastic tow (or tape). Heating is usually done using a hot gas (nitrogen) torch or a laser [2, 3]. For machines using the hot gas torch, the temperature at the nozzle of the torch can reach 950°C. This temperature can drop significantly at the noninjection point. The hot gas is usually

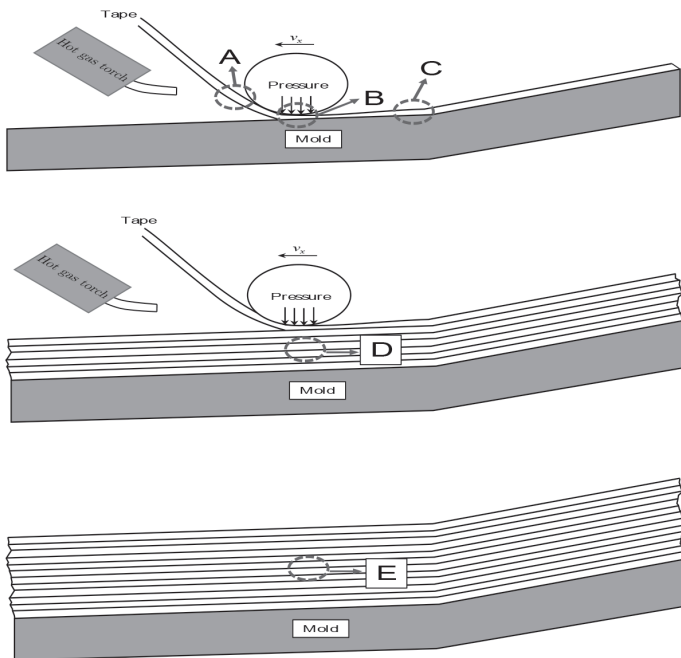

FIGURE 9.2 Five important stages of the material in the automated fiber placement process [1].

aimed at the roller (for the application of compression pressure) rather than directly on the thermoplastic tape. This means that the heating of the tape is done mostly by heat conduction from the roller rather than by convection from the hot gas. This is to avoid excessive temperature of the tape and possible erosion of the material due to the flow of the hot gas. For machines using a laser, different types of lasers (near infrared diode laser, ytterbium fiber laser) with powers ranging from 2 kW to 20 kW are available. The advantage of laser heating over torch heating is that laser heat is focussed on the composite rather than on the roller. This is because heating is done by the absorption of phonons by the fibers. The heated fibers then heat up the matrix material. As such, a soft roller such as silicone rubber may be used (as compared to steel rollers used in torch heating machine). However, the speed of movement of the machine has to be fast to avoid excessive heating. Fast speed of material deposition is desirable from the production point of view. On the other hand, too fast speed also gives rise to void formation.

- c. A mechanism to apply pressure on the deposited tow for consolidation.* It is necessary to apply pressure at the noninjection point (region B in Figure 9.2) to consolidate the material.

For thermoset matrix composites, this pressure does not have to very high. Normally, a load of about 40 lbs to 80 lbs is sufficient. This consolidation load helps to eliminate the need for pressing used in hand-lay-up and possibly the need to do frequent debulking, which can save time. In the case of thermoset matrix composites, the automated fiber placement only performs the deposition and consolidation of the stack of prepregs, but it does not perform the curing procedure. The stack of prepregs needs to be bagged and cured after the automated fiber placement process. This procedure has the disadvantage that two processes are involved (deposition by automated fiber placement and bagging and curing afterward), which is time consuming and costly. However, it has the advantage that defects that may be introduced during the automated fiber placement process may be eliminated during the subsequent curing process.

For thermoplastic matrix composites, a higher compression load is required for consolidation (normally around 100 lbs)

- e. A mechanism to move the noninjection point forward.* Once the material is deposited and bonded at the noninjection point (re-

gion B), the machine needs to advance the noninjection point to the next material strip for continuous processing. It is desirable to have as fast a speed as possible from the production point of view. However, it is also important to assure good quality of the part, particularly minimum void content. In the case of thermoset matrix composites, as there is a secondary process of curing in either an autoclave or oven, defects such as voids that occur during the deposition stage may be corrected during the secondary stage. As such, the speed of deposition can be high. However, in the case of thermoplastic matrix composites, high speed of deposition may compromise the quality of the laminates.

- f. A mechanism to maintain pressure after the noninjection point.* For the processing of thermoplastic matrix composites, after the noninjection point has moved away from the material strip of interest (region C in Figure 9.2) and because the matrix is still hot and soft, recurling of the fiber network may occur, which may give rise to deconsolidation. To avoid this deconsolidation, it is desirable to maintain the compression pressure for a certain amount of time until the matrix material is sufficiently rigid to constrain the recurling of the fiber networks. Whether a secondary compressor is available (at region C in Figure 9.2) depends on the type of machine.

2.2. Aspects Required to Cover to Gain Expertise in Automated Fiber Placement

To gain expertise on automated fiber placement, there are four basic aspects to cover. One is to have a good understanding of the behavior of the composites during the automated fiber placement. Second is the kinematics of the machine. Third is the software required for the operation of the machine, and fourth is the process for defect inspection.

2.2.1. Understanding the Behavior of the Composites During Automated Fiber Placement

Automated fiber placement machines can be used to process both thermoset matrix composites and thermoplastic matrix composites.

For thermoset matrix composites, the difference between using the machine and hand-lay-up is in the deposition of the materials onto the tool. Figure 9.3 shows the comparison between hand-lay-up and the use

of automated machines. The steps that follow the material deposition (bagging, curing, etc.) are essentially the same. As such, the switching from hand-lay-up to automated machines requires more understanding of the aspects of kinematics, control software, and defect inspection. The main concerns in relation to the composite materials relate to the existence of laps, gaps, and the steering of tows.

For thermoplastic matrix composites, there is significant difference between traditional compression molding and automated fiber placement. This is because compression molding is a batch process, while automated fiber placement is a continuous process. The duration of time that the melted material is subjected to compression pressure is much shorter in the case of automated fiber placement. The short duration of time the material is under compression has an important influence on the bond development between the layers. In addition, the removal of the compression while the material is still soft also has an important influence on the deconsolidation, which can give rise to delamination. The temperature variations from location to location within a particular layer, across the thickness of a particular layer, and from one layer to the next give rise to residual stresses and distortions. Besides, the relaxation of the thermoplastic polymer at the different temperatures and pressures adds to the complexity of the process. The use of an automated machine to process thermoplastic composites is a very complex process and needs a lot of study. On the other hand, processing of thermoplastic composites using automated fiber placement promises to provide net shape structures, which may not need a secondary process. This aspect is very attractive.

2.2.2. Kinematics of the Machine

The kinematics of the machine refer to components that provide the motion that control the fiber paths. Some machines use a gantry system whereas others use robots. The gantry system is usually used for large machines. It can provide bigger compression forces and stiffer systems than machines using robots. Machines usually have many degrees of freedom.

2.2.3. Control Software.

The motion of different parts of the machine are controlled by software. Two types of software are required. One is for the lay out of the

point-by-point paths of the courses. The fiber paths depend on the design of the final part, which include fiber orientation, lay-up sequence, and thickness. This software can be coupled with some sort of CAD software. Locations of gaps and laps may also be controlled using the software. The fiber paths should also take care of collision avoidance and a requirement to avoid laps or gaps. The second program is for the control of the hardware components of the machine to execute the paths. Compatibility between the first program and the second program is required.

2.2.4. Inspection of Defects

The inspection of defects that occurs during the automated fiber placement process can be done by manual visual inspection or by automation. Manual visual inspection is very slow and is not recommended. Automated inspection systems have been investigated. One system for thermoset composites uses a thermographic online monitoring system [10]. The system uses an infrared camera mounted onto the automated fiber placement machine. It monitors the temperature of the recently laid material right after the noninjection point. The variation of the thermographic image is correlated with the defects. It was shown that this system can detect tow geometry, gap/overlap, end of tow, twisted tow, foreign body, and change of surface material.

2.3. Advantages of Automated Fiber Placement Manufacturing of Composites

Automated fiber placement has many advantages over conventional methods as follows:

2.3.1. Faster Rate of Material Deposition—Reduced Debulking Time

With increasing use of composite materials in many engineering structures, there is urgent need to increase the rate of production. The normal rate of material deposition by hand-lay-up is about 2.2 lb/hr. The rate of material deposition by automated fiber placement depends on the type of machine. A machine that deposits multiple tows has a higher rate of material deposition than a machine that deposits one tow at a time. The normal rate of material deposition of an automated fiber placement machine is about 20 lb/hr [12].

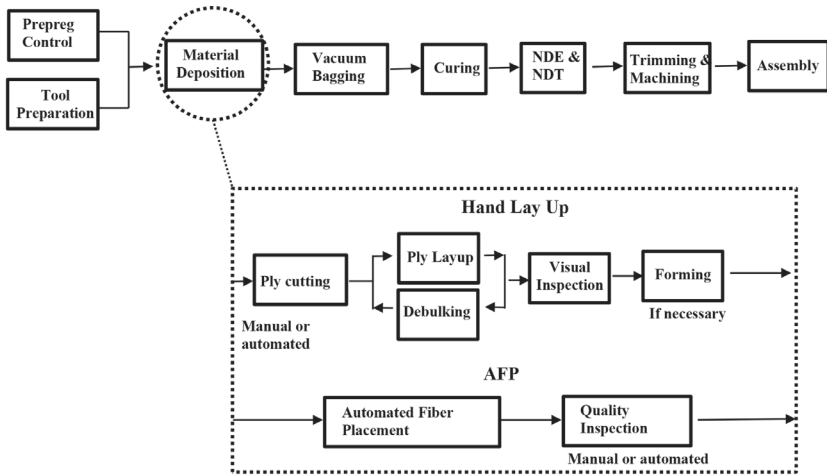

FIGURE 9.3 Comparison between hand-lay-up and automated fiber placement process for thermoset composites.

Besides the high rate of material deposition, the compaction applied during the automated fiber placement process helps to reduce the time required for debulking as usually occurring during the hand-lay-up process. A comparison between the hand-lay-up and automated fiber placement processes is shown in Figure 9.3.

2.3.2 Less Material Wastage

Because the process is one form of additive manufacturing, tows and layers of materials are deposited on design. As such, the material wastage is much less than in the case of hand-lay-up. Figure 9.4 shows the situation where a sheet of prepregs is cut at 45 degrees to make 45-degree layers in a laminate ABCD for the purpose of hand-lay-up. The cut-off materials at the corners are waste. There is a terminology in the aircraft industry called the Buy/Fly ratio referring to how much material ends up flying from the amount that was bought. It can be seen from Figure 9.4 that this ratio can be about 2:1. For parts with more complicated geometry, this ratio can go up to 3:1. This does not happen when narrow tows are placed at a certain desired orientation in the automated fiber placement process. Figure 9.5 shows the configuration to make the laminate ABCD using automated fiber placement lay-up

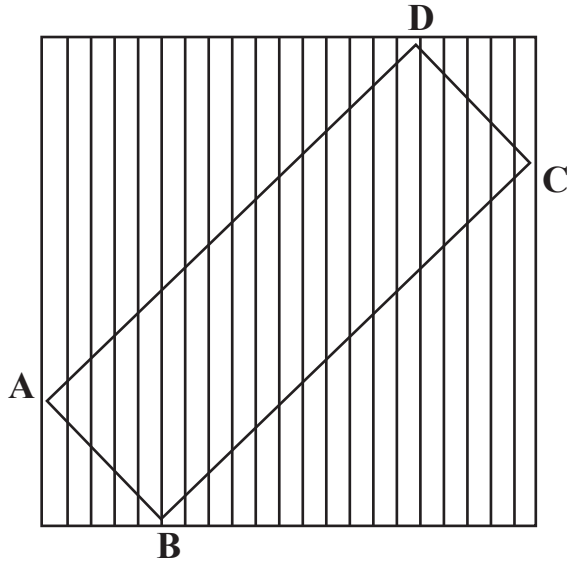

FIGURE 9.4 Corner pieces in a sheet of prepregs are cut off, resulting in material waste.

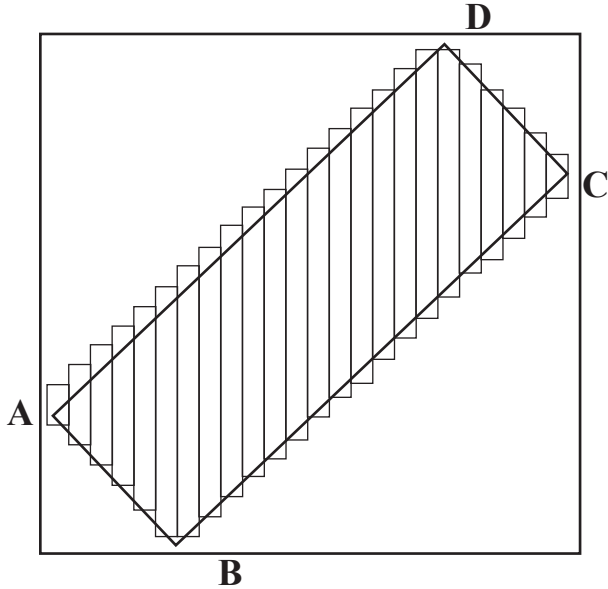

FIGURE 9.5 Less waste of material when the tows are laid down using automated fiber placement.

tow-by-tow. It can be seen that there is a lot less waste of material. Composite materials are expensive. The use of automated fiber placement can reduce the material waste, which in turn results in cost saving and more environmentally friendly manufacturing.

2.3.3. More Repeatability—Less Variability

Because automated fiber placement is done by machine, there is more repeatability and less variability in the quality of the part as compared to conventional process such as hand-lay-up, which depends on the skill of the workers at different time period of the work week.

2.3.4. Less Manual Labour Intensive

Conventional composite manufacturing technique such as hand-lay-up is labor intensive, whereas automated fiber placement is less labor intensive. The use of automated fiber placement evens out the difference in labor rates from one region to another.

2.3.5. Automated Fiber Placement is Essential for Large Structures

To deposit composite materials on large structures, it is not practical to use hand-lay-up where people have to climb up on large frames. The use of automation allows the construction of large structures more easily.

2.3.6. Ability to Steer Fibers

One unique characteristic of automated fiber placement as compared to other techniques for the manufacturing of composites is the ability to steer the fibers. As such, the fiber orientations can vary not only from one layer to another, but also from location to location within the same layer. It is then possible to orient the fibers in the direction where the load is high. This can result in more effective use of materials. One example is the case of a composite cylinder subjected to bending load as shown in Figure 9.6. The cylinder may buckle. The buckling resistance of the cylinder tends to happen on the compression side (top) of the cylinder.

Figure 9.7a shows the change of the fiber orientation θ in a cylinder with thickness having the lay-up sequence of $[0/\theta/90/-\theta/-\theta/90/\theta/0]_s$. At

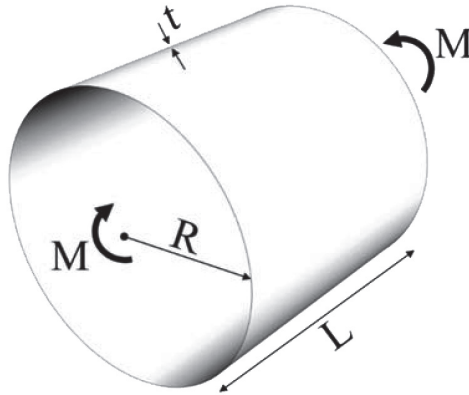

FIGURE 9.6 Composite cylinder subjected to bending loads [4].

the bottom of the cylinder (position T_1), θ has the value of about 7° . At the position T_2 , θ has a value of 0° . At T_7 , it has a value of about 48° , etc. The curve in Figure 9.7a was obtained using surrogate optimization procedure [4]. Figure 9.7b shows the steered fibers on the cylindrical mandrel.

The buckling load for this cylinder is compared with that made of quasi-isotropic lay-up [0/45/90/-45/-45/90/45/0]s, as shown in Figure 9.8.

The cylinder with steered fibers shows improvement of buckling resistance of about 20% (at $R/t = 900$) as compared to the cylinder made of constant fiber orientation. It can be seen from Figure 9.7a that the bottom of the cylinder, fibers, in the layers with variable fiber orientation, are mainly along the 0° direction, which support tensile load, whereas from the horizontal position to the top, fibers are oriented more along the 45° directions, which is similar to the fiber angle for the case of quasi-isotropic. At the bottom of the cylinder, the fact that the fibers are oriented more toward the 0° direction provides better resistance against tensile load.

Figure 9.9 shows the mode shapes of the cylinders where comparison between quasi-isotropic laminates and variable stiffness laminates are shown. For variable stiffness laminates, more deformation occurs on the compression side (top), which indicates that more materials participate into the resistance against the buckling. This in turn raises the buckling resistance of the structure.

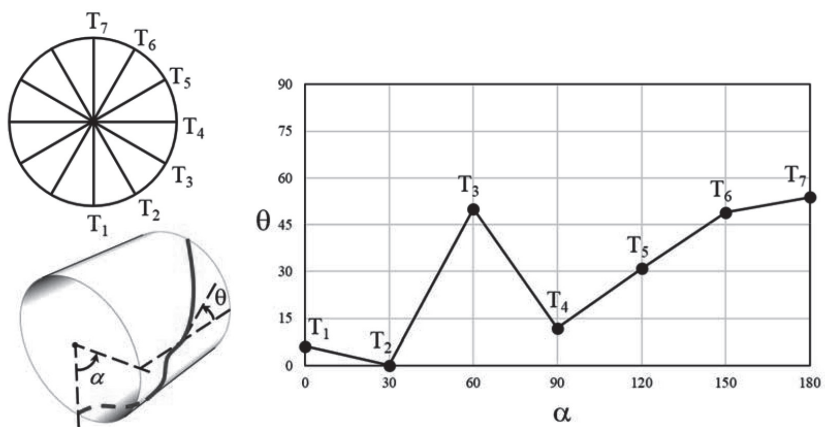

FIGURE 9.7a Distribution of fiber angles in the layer with variable fiber angles [4].

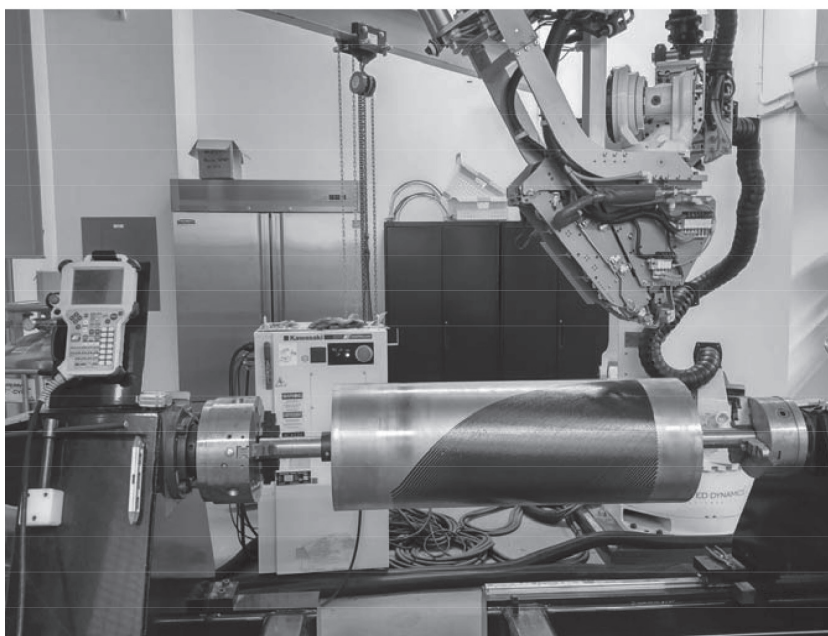

FIGURE 9.7b Steered fibers on a cylindrical mandrel.

Index

- Accelerator, 73, 82
- Activation, 70
- Activation energy, 196
- Adhesive, 29, 32
- Aggregately conductive materials, 125
- Aligning, 40
- Aliphatic, 68, 86
- Aluminum tool, 182
- Amine hydrogen, 76
- Amine hydrogen equivalent weight, 80
- Amines, 76
- Amorphous, 347
- Anhydride curing agents, 80
- Anhydrides, 76
- Anisotropic behavior, 38
- APC2, 350, 375
- Aramid fibers, 143, 144, 145
- Area over volume ratio, 109
- Aromatic, 68, 78
- Aromatic rings, 85
- Aspect ratio, 17, 23, 129
- Autoclave, 4, 14, 172, 225, 226, 227
- Autoclave molding, 3
- Autoclave processing, 177
- Autohesion, 356, 363
- Automated composites manufacturing, 387
- Automated fiber placement, 14, 15, 389, 390
- Availability, 43, 44, 55, 181
- Bagging film, 191
- Band forming mechanism, 256
- Barcol hardness test, 92
- Basket weave, 149, 150
- Benzene ring, 68
- Bismaleimide, 100
- Binders, 291
- Bisphenol A, 75
- Bleeder materials, 191
- Breather materials, 191
- Bonding, 15
- Boron fibers, 146
- Boron trifluoride methyl amine, 83
- Braid, 148, 152
- Braiding, 293, 295
- Braided, 20
- Breakable mandrels, 253
- Bridging step, 64
- Bulk compressive stresses, 164
- Bulk consolidation, 355, 356
- Bulk form, 23
- Bulk graphite, 186
- Bulk modulus, 355
- Bundle of fibers, 37
- Bundles, 19, 28, 29, 30
- C glass, 133, 134
- Capillary number, 320
- Carbon fibers, 137, 139, 142
- Carbon/carbon, 101

- Carbon matrix, 100, 101
- Carbon nanotubes, 120
- Catalysts, 63
- Catalyzed resin, 176
- Caul plate, 192
- Centipoise, 45
- Ceramic matrix, 108, 109
- Ceramic tooling, 186
- Chemical principle, 88
- Chopped strand mat, 270
- Circuit, 245
- Clays, 110, 111
- Coefficient of permeability, 305
- Coefficients of thermal expansion, 183
- Closed packing, 35
- Coefficients of thermal conductivity, 198
- Collapsible mandrels, 252
- Collimation, 273
- Colorants, 108
- Combination winding, 248
- Commingled fibers, 334, 339
- Compaction, 274, 276, 277
- Compaction roller, 390
- Compatibility, 43, 46, 52
- Composite volume, 43
- Compression molding, 9, 10, 11, 334, 342
- Compression strength, 42
- Condensation polymerization, 57, 58
- Consolidation, 215, 218, 219
- Continuous strands, 270
- Cooling, 366, 412
- Cooling rate, 372
- Coupling agent, 72, 135
- Crack propagation, 33
- Critical aspect ratio, 24
- Critical length, 42
- Cross link density, 77, 85
- Cross linking, 59, 64, 66
- Cross linking agent, 61
- Crystalline, 347
- Crystallization, 347, 371
- Curing, 19, 64, 66, 283
- Curing cycle, 224, 225
- Curing agent, 70
- Curing systems, 76
- Cut and paste, 293
- Darcy, 44, 45, 298, 329
- DDS amine curing agent, 81
- Debulking, 190
- Debulking time, 395
- Deconsolidation, 379, 412
- Defects, 19
- Deformation of a bed of fibers, 154
- Deformation of fiber bundle, 157
- Degree of autohesion, 365
- Degree of crystallinity, 412
- Degree of cure, 88, 193
- Degree of intimate contact, 362
- Delaminations, 324
- Demolding, 283
- Dialcohol (diol), 57
- Diacid, 57, 68
- Dielectric, 90
- Differential scanning calorimeters, 195
- Differential Scanning Calorimetry, 92, 93, 94
- Diglycidyl Ether of Bisphenol A, 75
- Diluents, 76
- Diol, 68
- Dipoles, 90
- Dissolvable mandrels, 254
- Dispersibility, 111
- Distortion, 408
- Distribution of fibers, 18
- Domino effect, 15, 28
- Double bond, 63, 64
- Drape, 37
- Dry process, 73
- Dry spots, 15, 32, 321
- Dynamic Mechanical Analyzer, 92
- Dynamic scanning, 93, 94
- Dyes, 108
- E glass, 133, 134
- Edge injectio, 310
- Elastic recovery of fiber network, 373
- Elasticity of fiber networks, 358
- Elastomeric tooling, 185, 186
- Electrical conductivity, 123

- Electrical principle, 90
- Electroformed nickel, 183, 184
- End closures, 249
- Energy associated with the atomic bonds, 67
- Energy balance, 197
- Environmental attack, 43
- Epichlorhydrin, 75
- Epoxidized phenolic novolacs, 76
- Epoxidyl group, 75
- Epoxies, 297
- Epoxy chemical structure, 74
- Epoxy equivalent weight, 81
- Epoxy group, 81
- Epoxy molecules, 52
- Epoxy resins, 73
- Ester, 57
- Ether linkage, 103
- Etherification, 82, 194
- Ethylene glycol, 71
- Exotherm, 76
- Exothermic reaction, 66
- Extractable mandrels, 253

- Fabric sandwich, 340
- Fabrics, 20, 147
- Fiber bundle, 163
- Fiber form, 23
- Fiber motion, 260
- Fiber network, 372
- Fiber path, 243
- Fiber placement, 13, 15, 239, 265, 334
- Fiber steering, 406, 407
- Fiber tension, 261
- Fiber to fiber contact, 36
- Fiber washing, 313, 316
- Fiber wetting, 319
- Fibers, 129, 148
- Fibers with clinging powders, 334, 339
- Filaments, 129, 130, 148
- Filament winding, 5, 6, 14, 21, 173, 239, 240
- Filaments, 20
- Fillers, 70
- Filling time, 311, 321
- Film stacking, 334

- Filter velocity, 44
- Flake form, 23
- Flexibility, 24
- Foam, 339
- Flow enhancement fabrics, 290
- Forming, 155
- Fracture, 32, 33
- Free radicals, 61

- Gaps, 403, 404, 405
- Gel coat, 176
- Geodesic path, 249
- Glass fibers, 131, 132
- Glycidyl, 74
- Graphite/epoxy tooling, 184

- Half lives, 63
- Hand-Lay-Up, 3, 4, 5, 14, 21, 172
- Hand Laminating, 175
- Harden, 19
- Hardeners, 76
- Helical winding, 242
- Heat of reaction, 200
- Heat transfer, 197, 344
- Hexagonal packing, 35
- High energy solids, 47
- High pressure mixing, 114
- High speed mixing, 116
- Homopolymerization, 82
- Hoop winding, 248
- Hot melt, 334, 335
- Human errors, 17
- Hybrids, 153
- Hydroquinone, 72

- Imide, 100
- Impregnation after shaping, 343
- Impregnation tank, 256
- In line braiding, 272
- In line winding, 272
- In mold cure, 322
- Incomplete cure, 326
- Infrared spectroscopy, 89
- Inhibitors, 70, 72
- Initiation step, 61
- Initiator, 53, 67

- Intimate contact, 357
- Injection molding, 286
- Injection strategies, 309
- Intercalants, 112, 113
- Interface, 43
- Interface area, 43
- Interfiber spacing, 36, 50
- Interphase, 135
- Interply slip, 360, 361
- Intraply shearing, 360
- Invar tool, 182
- Ion viscosity, 91
- Isophthalic acid, 68, 71
- Isothermal scanning, 93, 94

- Kozeny-Carman equation, 217, 306, 308
- Kozeny constant, 217

- Laps, 403
- Lay up sequence, 188
- Layer, 247
- Laying up, 187, 188
- Lewis acids, 76, 83
- Linker molecules, 53
- Linking, 53
- Liquid Composite Molding, 7, 8, 9, 15, 21, 173, 281, 282
- Long fiber, 48
- Longitudinal winding, 248
- Low energy liquids, 47
- Low Profile additives, 19, 296

- Macro flow, 315
- Maleic acid, 68, 71
- Maleic anhydride, 68, 71
- Mandrels, 251
- Mat, 149, 151
- Material wastage, 396, 397
- Matrix, 39, 51, 296
- Metal matrix, 108
- Mechanical principle, 91
- Melting, 344
- Methacrylate, 97
- Methyl ethyl ketone peroxide, 61, 63, 67

- Micro braids, 339, 341
- Micro flow, 315
- Misorientation, 17
- Mold deflection, 313
- Mold filling, 298
- Molding, 155
- Moldless composites manufacturing, 413
- Modulus, 229, 230

- Nanoclay, 111
- Nanocomposites, 109
- Nano particle, 109
- Natural clays, 111
- Netting analysis, 257
- NIP point, 390
- Non injection point (NIP), 391, 392, 393
- Non-oxidative, 141
- Non-woven, 269
- Nozzle, 390

- Open packing, 35
- Ordered molecule, 347
- Organic fibers, 143
- Organoclays, 114
- Orientation of fibers, 16
- Orthophthalic acid, 68, 71
- Orthophthalic anhydride, 71
- Overlacing, 17
- Out-of-Autoclave, 4, 18, 95, 234
- Out of dimensions, 228, 232
- Oxidation, 24
- Oxidative, 141

- Partially linked network, 53
- Parts per hundred (phr), 49
- Pattern, 245
- PEEK, 106, 332, 350
- PEI, 106, 332
- PEKK, 106, 332, 375
- Percolation, 358, 361
- Percolation threshold, 122
- Permeability, 37, 38, 40, 216, 278
- Permeability matrix, 44, 45
- Peripheral injection, 310
- Peroxides, 61, 64, 99
- Physical properties, 350

- Pigments, 108
- Pitch, 140
- Phenolics, 100
- Photo activated curing systems, 67
- Photo initiators, 67
- Photon energy, 67
- Plain weave, 149, 150
- Point injection, 310
- Polar winding, 242
- Polyacrylonitrile, 137, 138
- Polyaryl sulfone, 104
- Polyester, 53, 56, 57, 59, 64, 70, 296
- Polyester properties, 67
- Polyester resins, 70
- Polyetheretherketone, 55, 103
- Polyether sulfone, 104
- Polyethylene fibers, 145, 146
- Polyimide, 99
- Polymers, 57
- Polyphenylene sulfide, 104
- Polysulfone, 104
- Porous areas, 326
- Pot, 73
- Pot life, 73, 86
- Powder form, 23
- Powder clinging towpregs, 337
- PPS, 106, 332
- Precursor, 137, 140
- Preform, 20, 291, 292
- Preforming, 282, 293
- Preliminary material combinations, 335
- Prepreg, 20, 86, 95, 178, 179, 180, 181, 236
- Pressure gradient, 44
- Pressure vessel, 5
- Primary amines, 77, 194
- Process window, 323
- Propylene glycol, 71
- Pull rate, 278
- Pultrability, 273
- Pultrusion, 7, 8, 14, 155, 173, 267, 268
- Pyrolysis, 101
- Pyrolytic coating, 141
- Quality control, 87
- Quenching, 373
- Race tracking, 313, 315, 317
- Radial flow, 301, 310
- Radially convergent flow, 303, 304
- Radially divergent flow, 301, 304
- Radicals, 63, 64
- Rate of cooling, 379
- Reactants, 67
- Reaction rate, 200
- Rectilinear flow, 299, 309
- Reactivity, 323
- Reinforcement forms, 147
- Reinforcements, 129, 250
- Relative concentration, 83
- Release agent, 186
- Repeatability, 398
- Reptation, 364
- Residual stresses, 228, 232, 233, 322
- Resin boils over, 319
- Resin degradation, 354
- Resin film infusion, 289
- Resin flow, 215, 216, 358
- Resin infusion, 283
- Resin kinetics, 194
- Resin pocket, 215
- Resin rich area, 18, 316
- Resin shrinkage, 228
- Resin system formulator, 73
- Resin transfer molding, 55, 286
- Resins, 250, 271
- Roller, 17
- Roving, 148, 149, 269
- Rubber tooling, 185
- Rule of mixtures, 18
- S glass, 133, 134
- Satin weave, 150
- SCRIMP, 15
- Seaman composite resin infusion molding process, 15, 287
- Secondary amines, 78, 194
- Self similar crack, 32
- Shear load transfer, 41
- Shear strength, 42
- Shear resistance, 37
- Shear transfer, 33
- Shearing flow, 360

- Shelf life, 72, 102
Shell Epon, 828, 74
Short fiber, 48
Shrink, 19
Shrinkage, 19, 92, 229, 231
Shrinkage control additives, 296
Silane, 136
Silicon carbide fibers, 146
Simulation, 382
Single bond, 63, 64
Slurry, 339
Solidification, 19, 372
Solubility, 291
Solvent removal, 24
Solvent solution, 334
Solvent swell, 88
Spray up, 293, 294
Spindle axis, 389
Square array, 154
Steel tool, 182
Steer fibers, 398, 399, 400, 401
Stitching, 17
Stoichiometric, 80
Storage life, 72
Strain energy release rate, 117
Strand, 148
Structural reaction injection molding, 286
Styrene, 61, 64
Surface coating, 142
Surface energy, 46, 52
Surface finish, 19, 325
Surface polymerization, 340
Surface tension, 46, 319
Surface treatment, 135, 141
Swirl mat, 151
- Tacky, 235
Tape, 148, 334, 335, 336
Tensioning device, 255
Tertiary amines, 78, 82
Tetraglycidylmethylene dianiline, 76
TGDDM, 74
Thermal principle, 92
Thermal properties, 199
Thermo forming, 293, 294
Thermoplastic composites, 21, 329
Thermoplastic matrix, 52
Thermoplastic resin, 55, 101
Thermoset, 52
Thermoset matrix, 56
Thermoset polymer, 52
Thermo stamping, 9, 11, 12, 375
Three dimensional weaves, 153
Thermo dynamically compatible, 47
Thermoplastic matrix, 332
Thermoplastic resin, 330
Thick laminates, 210
Thickness change, 380
Three roll mixing, 122
Time temperature transformation, 219
Tool, 283
Tool preparation, 182
Tow preg, 20
Tows, 25, 147, 148, 149
Transverse flow, 360, 361
Transversely isotropic, 45
- Ultrasonic cure monitoring, 92
Ultraviolet rays, 67
- Vacuum assisted liquid composite molding, 15
Vacuum assisted resin transfer molding 287, 288
Vacuum Bag Only, 4, 234
Vapor deposition, 24
Variability, 398
Veils, 290
Vinyl ester, 96, 98, 99, 296
Viscosity, 19, 45, 55, 56, 72, 211, 212, 213, 252
Voids, 19, 222, 224, 317, 322
Volume fraction, 17, 18, 34, 48
- Warping, 322
Waviness, 157, 406, 407
Wavy, 17
Weave, 149
Weaving (3D), 17
Weft knitting, 293, 295
Weight fraction, 48

- Wet lay up, 175
- Wet process, 73
- Wetting, 19, 46
- Whiskerisation, 141
- Winding, 155, 241
- Winding pattern, 243
- Woven, 269
- Woven fabric, 149
- Wrinkling, 382
- X Ray pattern, 115, 118
- Yarn, 148
- Z pinning, 17
- 4-harness satin, 150
- 4D printing, 413
- 8-harness satin, 150

About the Author

DR. SUONG VAN HOA is a professor at the Department of Mechanical and Industrial Engineering of Concordia University, Montreal, Quebec, Canada. He obtained his B.Sc. from California State University San Luis Obispo, Master of Applied Science and Ph.D. from University of Toronto, Canada.

He became a professor at the Department of Mechanical Engineering of Concordia University in 1977. He was chair of the department from 1994 till 2000 and then again from 2003 till 2006. He has been working on Polymer-Composites since 1979. He established the Concordia Center for Composites in 1993 and has been Director of the Center since. He formed the Canadian Association for Composite Structures and Materials (CACMA) in 1988. He co-established together with a Japanese colleague the series of Canada-Japan workshop on composites since 1996.

Dr. Hoa is a fellow of the Canadian Academy of Engineering, American Society of Mechanical Engineers, Engineering Institute of Canada, Canadian Society for Mechanical Engineering, and of the American Society for Composites. He is a recipient of the Society of Automotive Engineers Ralph Teetor award, the Canadian Society for Mechanical Engineering G.H. Duggan medal, the Synergy award from the Natural Sciences and Engineering Research Council of Canada, the Association des Directeurs de Recherche Industrielle du Quebec prize, the NanoQuebec Nano Academia prize, the ASC/Destech award in composites, and he is a research fellow of Pratt & Whitney Canada Ltd.

Dr. Hoa has been carrying research and teaching on polymer composites since 1979 and polymer nanocomposites since 2000. He has been collaborating with many companies in composites in Canada, USA and internationally.